



PPN 5X-10X-18X-25X
LCN 5X-10X-18X



PPF 5X-10X-18X-25X
LCF 5X-10X-18X

uso e manutenzione **IT**

use and maintenance **GB**

emploi et entretien **FR**

Benutz und Wartungsanleitung **DE**

uso y mantenimiento **ES**

uso e manutenção **PT**

использование и техобслуживание **PY**

PPN/PPF5X-10X-18X-25X LCN/LCF5X-10X-18X

I



PELAPATATE E LAVACOZZE

INDICE

1 INFORMAZIONI GENERALI

Descrizione della macchina.....	4
Caratteristiche tecniche.....	4
Dimensioni d'ingombro.....	5

2 INFORMAZIONI SULL' INSTALLAZIONE

Imballo e disimballo.....	7
Zona d'installazione.....	7
Collegamento elettrico.....	7
Allacciamento idraulico.....	7

3 INFORMAZIONI SULL' USO E LA PULIZIA

Uso della macchina	8
Accessori a richiesta.....	9

ALLEGATI

Schema elettrico

INFORMAZIONI GENERALI 1

Descrizione della macchina

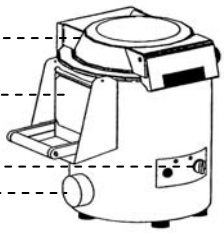
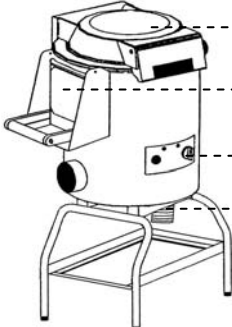
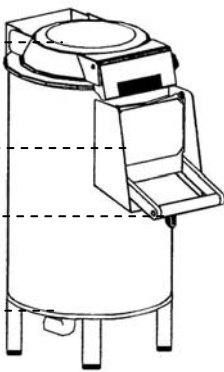
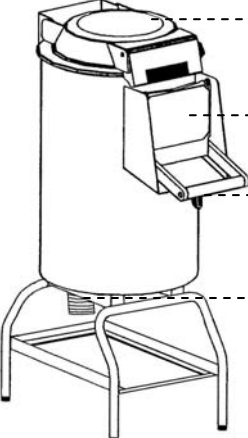
<p>MOD.PPN-LCN5</p>  <p>Coperchio ----- Sportello scarico ----- Pannello comandi ----- Scarico acqua -----</p>	<p>MOD.PPF-LCF5</p>  <p>Coperchio ----- Sportello scarico ----- Pannello comandi ----- Scarico acqua -----</p>
<p>MOD.PPN/LCN10-18-PPN25</p>  <p>Coperchio ----- Sportello scarico ----- Pannello comandi ----- Scarico acqua -----</p>	<p>MOD.PPF/LCF10-18-PPF25</p>  <p>Coperchio ----- Sportello scarico ----- Pannello comandi ----- Scarico acqua -----</p>

Caratteristiche tecniche

Descrizioni	Unità di misura	PPN5	PPF5	PPN10	PPF10	PPN18	PPF18	PPN25	PPF25
Alimentazione di energia elettrica	V Hz Ph	230V 50Hz 1Ph 230/400V 50Hz 3/3Ph+N							
Potenza	kW (HP)	0.37 (0.5)	0.37 (0.5)	0.75 (1)	0.75 (1)	1.1 (1.5)	1.1 (1.5)	1.1 (1.5)	1.1 (1.5)
Carico patate	kg	5	5	10	10	18	18	25	25
Peso netto	kg	26	28	37	36	43	42	70	70
Peso con imballo	kg	36	38	47	46	53	52	88	88
Installazione		Da banco	A terra						

Descrizioni	Unità di misura	LCN5	LCF5	LCN10	LCF10	LCN18	LCF18
Alimentazione di energia elettrica	V Hz Ph	230V 50Hz 1Ph 230/400V 50Hz 3/3Ph+N					
Potenza	kW (HP)	0.26 (0.35)	0.26 (0.35)	0.55 (0.75)	0.55 (0.75)	0.9 (1.2)	0.9 (1.2)
Carico cozze	kg	5	5	10	10	18	18
Peso netto	kg	26	28	37	36	43	42
Peso con imballo	kg	36	38	47	46	53	52
Installazione		Da banco	A terra				

Dimensioni d'ingombro

PPN-LCN5				PPN-LCN10				PPN-LCN18			
mm	A	B	C								
PPN-LCN5	500	750	920								
PPN-LCN10	550	850	1120								
PPN-LCN18	550	850	1120								
PPF-LCF5				PPF-LCF10				PPF-LCF18			
mm	A	B	C					A	B	C	mm
PPF-LCF5	500	750	920								
PPF-LCF10	550	850	1120								
PPF-LCF18	550	850	1120								
				+							
								ACCI			

Dimensioni d'ingombro

PPN25				PPF25			
mm	A	B	C	A	B	C	mm
PPN25	600	1050	1230	600	1050	1230	PPF25
				450	680	500	ACCB

INFORMAZIONI SULL' INSTALLAZIONE 2

Imballo e disimballo

La macchina è imballata in un cartone con l'inserimento di poliestere espanso per garantire la perfetta integrità durante il trasporto.

- Movimentare l'imballo rispettando le istruzioni.
- Aprire l'imballo e verificare l'integrità di tutti i componenti. Conservare l'imballo per futuri traslochi.
- Effettuare il sollevamento della macchina come indicato e posizionarla nella zona adibita all'installazione.

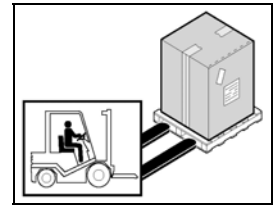

Zona d'installazione

La zona prestabilita deve essere adeguatamente illuminata e deve disporre di una presa di distribuzione d'energia elettrica. Il piano d'appoggio deve essere sufficientemente ampio, ben livellato ed asciutto. L'installazione deve avvenire in ambienti con atmosfera non esplosiva. In ogni modo, l'installazione deve essere eseguita tenendo conto anche delle leggi vigenti in materia di sicurezza sul lavoro.

Collegamento elettrico

⚠ PERICOLO – ATTENZIONE: Il collegamento elettrico alla rete di alimentazione deve essere eseguito da personale specializzato.

Accertarsi della perfetta efficienza dell'impianto di messa a terra dello stabilimento. Verificare che la tensione di linea (V) e la frequenza (Hz) corrispondano a quelli della macchina (Vedere la targhetta di identificazione e lo schema elettrico). La macchina è dotata di cavo elettrico al quale collegare una spina multipolare. La spina è da collegare ad un interruttore a muro provvisto di differenziale.

Collegamento trifase

Avviare la macchina per pochi attimi e verificare che la rotazione dell'utensile sia corretta. Nel caso in cui la rotazione non sia corretta, togliere tensione ed invertire due delle tre fasi nella spina.

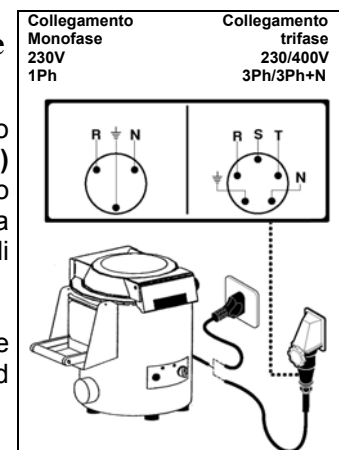

Allacciamento idraulico

Effettuare il collegamento alla rete idrica tramite il tubo flessibile in dotazione (1500mm.) con attacchi da 3/4" procedendo nel seguente modo:

-Allacciarsi all'ingresso acqua **A** sul retro dell'apparecchio.

-Collegare l'altra estremità del tubo flessibile alla rete idrica. Un rubinetto **B** di intercettazione dovrà essere installato a monte dell'apparecchio, sulla tubazione di alimentazione dell'acqua.

-Lo scarico **C** dovrà essere in pendenza per favorire l'evacuazione delle scorie; la tubazione di scarico dovrà avere un $\varnothing 50\text{mm}$. per i modelli PPN\LCN10-18-PPN25 e $\varnothing 90\text{mm}$. per i PPF\LCF5-10-18-PPF25. Il modello PPN\LCN5, essendo un apparecchio da banco, dovrà scaricare **D** in un lavandino o similare posto alla sua sinistra.

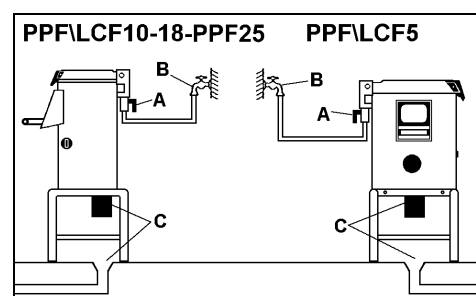
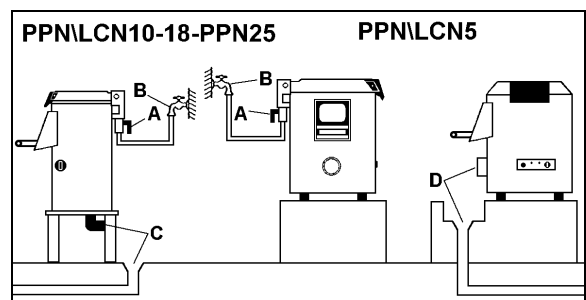

INFORMAZIONI SULL' USO E LA PULIZIA **3**

Uso della macchina

Aprire il coperchio trasparente tirando la maniglia **A** fino allo scatto di apertura.

Inserire il piattello prescelto e caricare la vasca con il prodotto da trattare.

Richiudere il coperchio bloccandolo ed accertarsi del bloccaggio dello sportello di scarico **B**.

Inserire l'interruttore generale a muro.

Avviare l'apparecchio ruotando la manopola **C** del timer sul tempo desiderato per il ciclo di lavoro.

Verificare l'ingresso dell'acqua di lavaggio: agendo manualmente sul rubinetto **D** posto sulla macchina.

Al termine del ciclo impostato la macchina si fermerà automaticamente.

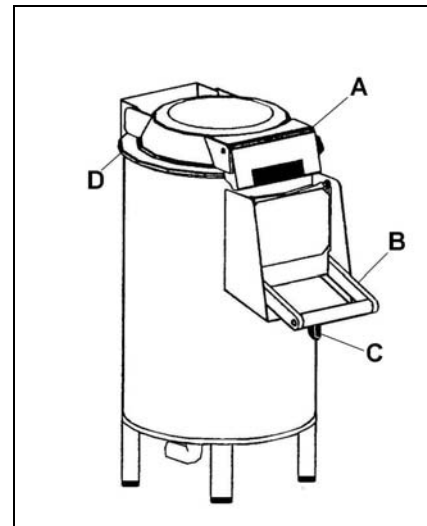
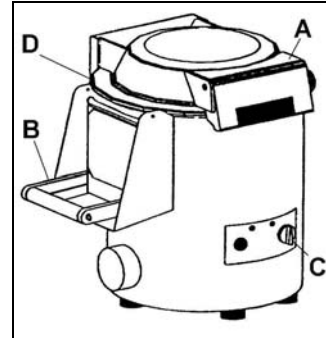

Interrompere l'immissione dell'acqua agendo sul rubinetto **D**.

Per scaricare il prodotto trattato aprire lo sportello di scarico **B** dopo aver posizionato un raccoglitore sotto lo scarico stesso, ruotare il timer **C** per consentire la rotazione a secco del piattello e tenere con l'altra mano lo sportello di scarico in modo da controllare la fuoriuscita del prodotto senza venire a contatto.



⚠ PERICOLO – ATTENZIONE: Non introdurre mai la mano attraverso lo sportello di scarico per favorire la fuoriuscita del prodotto.

Accessori a richiesta

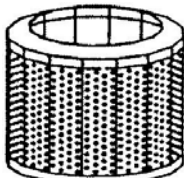
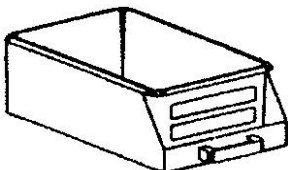
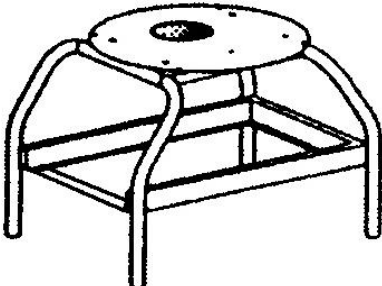
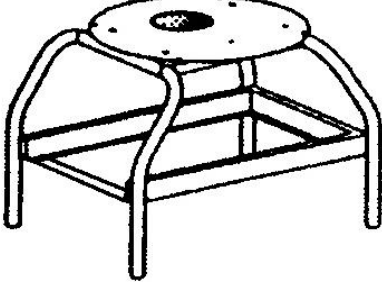
<p>PTA-PAB: pelare tuberì con il piattello abrasivo (solo mod.PPN\PPF5-10-18)</p>	
<p>PTB: pelare tuberì con il piattello abrasivo (solo mod.PPN\PPF25)</p>	
<p>PPC: pulire cozze e similari con il piattello a spazzole (solo mod.LCN\LCF5-10-18)</p>	
<p>CCV: centrifugare verdure in foglia con il cestello (solo mod.PPN\PPF10-18-25)</p>	
<p>CCF: raccogliere scorie (solo mod.PPF\LCF5-10-18-PPF25)</p>	
<p>CI: modificare mod.PPN\LCN5-10-18 in mod.PPF\LCF5-10-18</p>	
<p>CB: modificare mod.PPN25 in mod.PPF25</p>	

PPN/PPF5X-10X-18X-25X

LCN/LCF5X-10X-18X



POTATO PEELER AND MUSSEL WASHER

CONTENTS

1 GENERAL INFORMATION

Machine description.....	4
Specification.....	4
Overall dimensions.....	5

2 INSTALLATION

Packing and unpacking.....	7
Installation area.....	7
Electric connection.....	7
Connection to water supply.....	7

3 OPERATION AND CLEANING

Use of the machine.....	8
Optional accessory gadgets.....	9

ANNEXES

Electrical wiring diagram	
---------------------------	--

GENERAL INFORMATION 1

Machine description

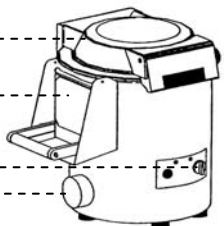
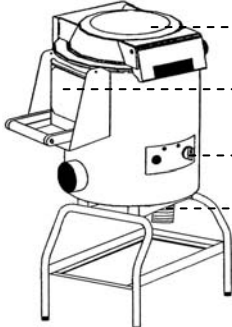
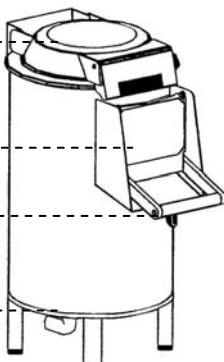
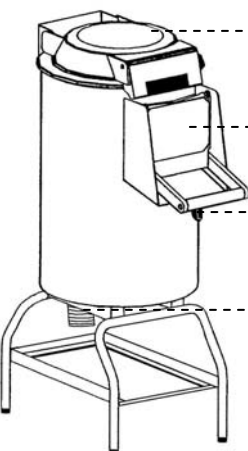
<p>MOD.PPN-LCN5</p>  <p>Lid -----</p> <p>Outlet door -----</p> <p>Control board -----</p> <p>Water drain -----</p>	<p style="text-align: right;">MOD.PPF-LCF5</p>  <p style="text-align: right;">Lid -----</p> <p style="text-align: right;">Outlet door -----</p> <p style="text-align: right;">Control board -----</p> <p style="text-align: right;">Water drain -----</p>
<p>MOD.PPN/LCN10-18-PPN25</p>  <p>Lid -----</p> <p>Outlet door -----</p> <p>Control board -----</p> <p>Water drain -----</p>	<p style="text-align: right;">MOD.PPF/LCF10-18-PPF25</p>  <p style="text-align: right;">Lid -----</p> <p style="text-align: right;">Outlet door -----</p> <p style="text-align: right;">Control board -----</p> <p style="text-align: right;">Water drain -----</p>

Specifications

Description	Unit of measure	PPN5	PPF5	PPN10	PPF10	PPN18	PPF18	PPN25	PPF25
Electric power input	V Hz Ph	230V 50Hz 1Ph 230/400V 50Hz 3/3Ph+N							
Power	kW (HP)	0.37 (0.5)	0.37 (0.5)	0.75 (1)	0.75 (1)	1.1 (1.5)	1.1 (1.5)	1.1 (1.5)	1.1 (1.5)
Potatoes load	kg	5	5	10	10	18	18	25	25
Net weight	kg	26	28	37	36	43	42	70	70
Packaged weight	kg	36	38	47	46	53	52	88	88
Installation		On the table	On the floor						

Description	Unit of measure	LCN5	LCF5	LCN10	LCF10	LCN18	LCF18
Electric power input	V Hz Ph	230V 50Hz 1Ph 230/400V 50Hz 3/3Ph+N					
Power	kW (HP)	0.26 (0.35)	0.26 (0.35)	0.55 (0.75)	0.55 (0.75)	0.9 (1.2)	0.9 (1.2)
Potatoes load	kg	5	5	10	10	18	18
Net weight	kg	26	28	37	36	43	42
Packaged weight	kg	36	38	47	46	53	52
Installation		On the table	On the floor				

Overall dimensions

PPN-LCN5				PPN-LCN10				PPN-LCN18			
mm	A	B	C								
PPN-LCN5	500	750	920								
PPN-LCN10	550	850	1120								
PPN-LCN18	550	850	1120								
PPF-LCF5				PPF-LCF10				PPF-LCF18			
mm	A	B	C					A	B	C	mm
PPF-LCF5	500	750	920								
PPF-LCF10	550	850	1120								
PPF-LCF18	550	850	1120								
				+							
								390	580	470	ACCI

Overall dimensions

PPN25				PPF25			
mm	A	B	C				
PPN25	600	1050	1230				
				A	B	C	mm
				600	1050	1230	PPF25
				450	680	500	ACCB

INSTALLATION 2

Packing and unpacking

The machine will come packaged in a carton with foamed polyester inserts to guarantee perfect safety during transport.

- Handle the carton in compliance with the instructions.
- Open the carton and make sure that all components are intact. Keep the carton for any future machine removal.
- Lift the machine according to the instructions and place it in its selected setting for installation.

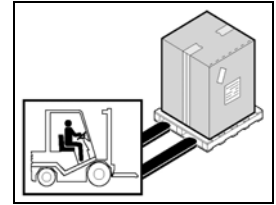

Installation area

The selected machine work setting must be sufficiently lit and have an electric power outlet. The worktop must be sufficiently large, perfectly level and dry. The machine should be installed in non-explosive environments. In any case, installation should be carried out by taking into account any applicable industrial safety regulations in force.

Electric connection

⚠ DANGER – CAUTION: Electric connection to the power mains should be executed by skilled engineers.

Check for the perfect efficiency of the plant grounding system. Make sure that the line voltage (**V**) and frequency (**Hz**) correspond to the machine ratings (refer to the machine identification plate and wiring diagram). The machine comes equipped with an electric cable with plug. Plug the machine into a main wall switch with differential.

Three-phase connection

Start the machine for just a few seconds and check that the beater turns in the right direction. If this is not the case, disconnect power and exchange two of the three phase wires in the plug.

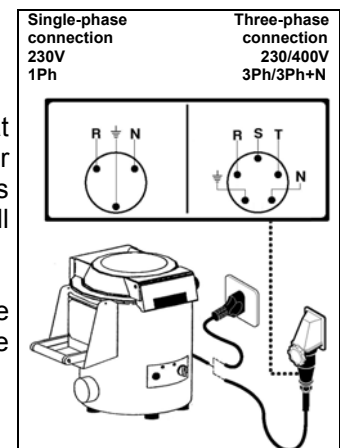

Connection to water supply

Connect to water supply by means of the supplied hose (1500mm.) and 3/4" couplings. Proceed as follows:

-Connect hose to inlet **A** on the machine back side.

-Connect the other end of the hose to water supply. A water trap **B** is to be installed on the water supply pipe before the machine.

-Incline the water drain **C** to facilitate scrap draining; the underground draining pipe must be $\varnothing 50\text{mm}$. for models PPN\LCN10-18-PPN25 and $\varnothing 90\text{mm}$. for models PPF\LCF5-10-18-PPF25. The model PPN\LCN5 is a table-top machine in order to drain **D** into a washbasin or similar, placed on the left of the machine.

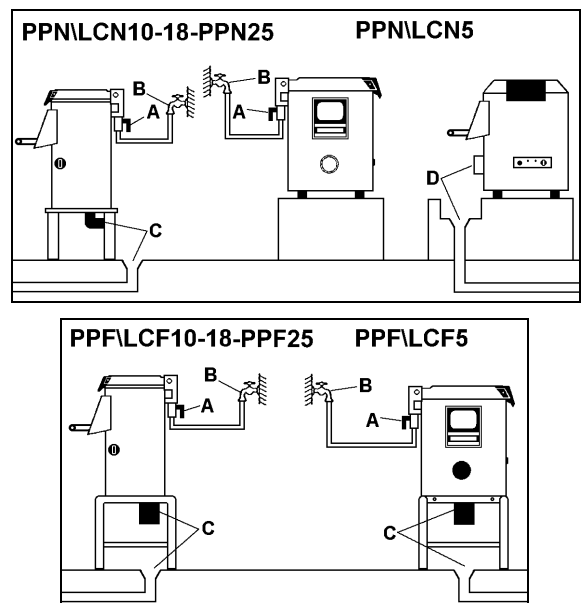

OPERATION AND CLEANING 3

Use of the machine

Open the transparent lid by pulling the handle **A** until it clicks open.

Put the disk in and load the tank with the product to be processed.

Lock the lid and make sure the outlet door **B** is locked.

Switch the wall master switch on.

Start the appliance by turning the timer knob **C** on the required working-cycle time length.

Make sure rinsing water flowing in, the tap **D** located on the machine must be turned on manually.

The machine will automatically stop on ending the set cycle.

Turn off the water tap **D**.

In order to let the processed product out open the outlet door **B** after putting a container underneath it. Then turning the timer knob **C** to allow the on-empty rotation of the disk. Meanwhile hold the outlet door so as to check the product come out without touching it.

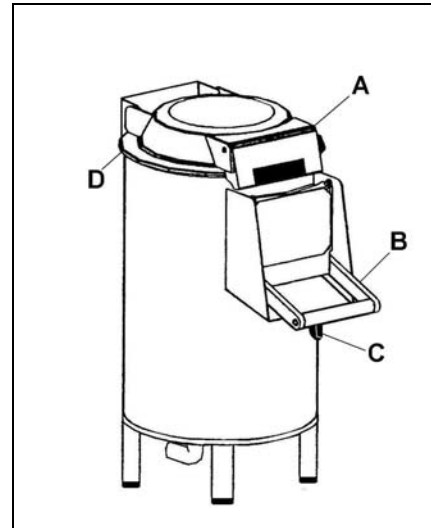
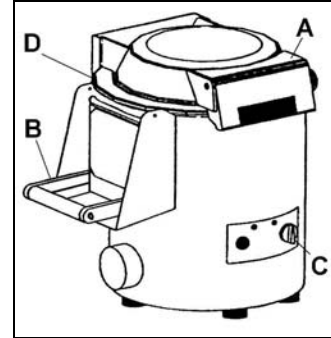

⚠ DANGER – CAUTION: never put your hand inside the outlet door to help the product come out.

Optional accessory gadgets

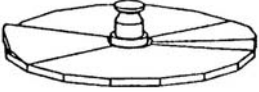
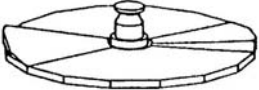
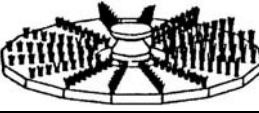
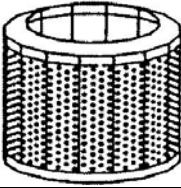
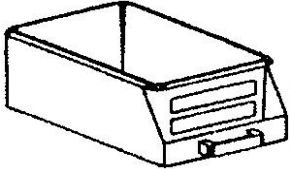
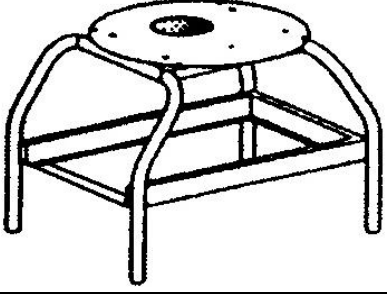
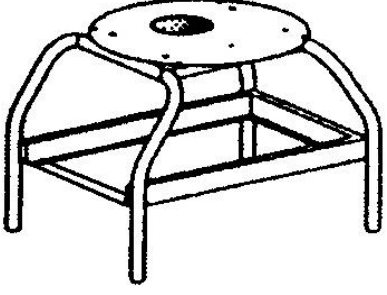
<p>PTA-PAB: peeling tubers with scraping disk (only mod.PPN\PPF5-10-18)</p>	
<p>PTB: peeling tubers with scraping disk (only mod.PPN\PPF25)</p>	
<p>PPC: cleaning mussels and shellfish with brushes disk (only mod.LCN\LCF5-10-18)</p>	
<p>CCV: centrifuging leafy vegetables with basket (only mod.PPN\PPF10-18-25)</p>	
<p>CCF: Collecting slags (only mod.PPF\LCF5-10-18-PPF25)</p>	
<p>CI: Changing mod.PPN\LCN5-10-18 in mod.PPF\LCF5-10-18</p>	
<p>CB: Changing mod.PPN25 in mod.PPF25</p>	

PPN/PPF5X-10X-18X-25X

LCN/LCF5X-10X-18X

F



ÉPLUCHEUR À POMMES DE TERRE ET LAVE MOULES

TABLE DES MATIÈRES

1 INFORMATIONS GÉNÉRALES

Description de la machine.....	4
Caractéristiques techniques.....	4
Dimensions d' encombrement.....	5

2 INFORMATIONS SUR L' INSTALLATION

Emballage et déballage.....	7
Zone d' installation.....	7
Branchement électrique.....	7
Branchement hydraulique.....	7

3 INFORMATION SUR L' EMPLOI ET LE NETTOYAGE

Utilisation de la machine	8
Accessoires sur demande.....	9

ANNEXES

Schéma électrique	
-------------------	--

INFORMATIONS GÉNÉRALES 1

Description de la machine

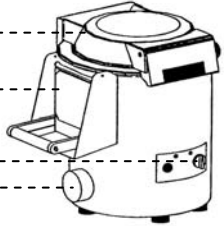
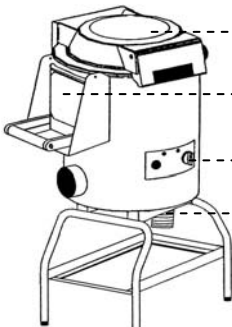
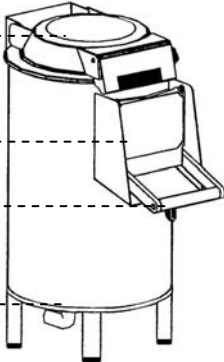
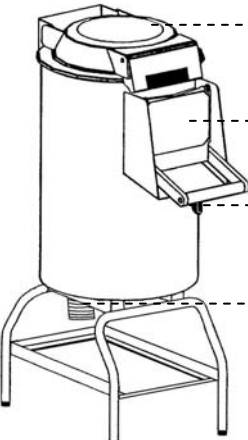
<p>MOD.PPN-LCN5</p>  <p>Couvercle</p> <p>Porte d'évacuation</p> <p>Panneau commandes</p> <p>Evacuation eau</p>	<p>MOD.PPF-LCF5</p>  <p>Couvercle</p> <p>Porte d'évacuation</p> <p>Panneau commandes</p> <p>Evacuation eau</p>
<p>MOD.PPN/LCN10-18-PPN25</p>  <p>Couvercle</p> <p>Porte d'évacuation</p> <p>Panneau commandes</p> <p>Evacuation eau</p>	<p>MOD.PPF/LCF10-18-PPF25</p>  <p>Couvercle</p> <p>Porte d'évacuation</p> <p>Panneau commandes</p> <p>Evacuation eau</p>

Caractéristiques techniques

Descriptions	Unité de mesure	PPN5	PPF5	PPN10	PPF10	PPN18	PPF18	PPN25	PPF25
Alimentation en énergie	V Hz Ph	230V 50Hz 1Ph 230/400V 50Hz 3/3Ph+N							
Puissance	kW (HP)	0.37 (0.5)	0.37 (0.5)	0.75 (1)	0.75 (1)	1.1 (1.5)	1.1 (1.5)	1.1 (1.5)	1.1 (1.5)
Chargement pommes de terre	kg	5	5	10	10	18	18	25	25
Poids net	kg	26	28	37	36	43	42	70	70
Poids avec emballage	kg	36	38	47	46	53	52	88	88
Installation		Sur table	Sur le sol						

Descriptions	Unité de mesure	LCN5	LCF5	LCN10	LCF10	LCN18	LCF18
Alimentation en énergie	V Hz Ph	230V 50Hz 1Ph 230/400V 50Hz 3/3Ph+N					
Puissance	kW (HP)	0.26 (0.35)	0.26 (0.35)	0.55 (0.75)	0.55 (0.75)	0.9 (1.2)	0.9 (1.2)
Chargement pommes de terre	kg	5	5	10	10	18	18
Poids net	kg	26	28	37	36	43	42
Poids avec emballage	kg	36	38	47	46	53	52
Installation		Sur table	Sur le sol				

Dimensions d'encombrement

				PPN-LCN5		PPN-LCN10		PPN-LCN18	
mm	A	B	C						
PPN-LCN5	500	750	920						
PPN-LCN10	550	850	1120						
PPN-LCN18	550	850	1120						
				PPF-LCF5		PPF-LCF10		PPF-LCF18	
mm	A	B	C	 					
PPF-LCF5	500	750	920						
PPF-LCF10	550	850	1120						
PPF-LCF18	550	850	1120						
				A	B	C	mm		
				390	580	470	ACCI		

Dimensions d' encombrement

PPN25				PPF25			
mm	A	B	C				
PPN25	600	1050	1230				
				A	B	C	mm
				600	1050	1230	PPF25
				450	680	500	ACCB

INFORMATIONS SUR L'INSTALLATION 2

Emballage et déballage

La machine est emballée dans du carton avec l'insertion de polyester expansé pour assurer son intégrité parfaite pendant le transport.

- Manutentionner l'emballage en respectant les instructions.
- Ouvrir l'emballage et vérifier l'intégrité de tous les composants. Garder l'emballage pour des déménagements futurs.
- Effectuer le levage de la machine comme il est indiqué et la placer dans la zone destinée à l'installation.

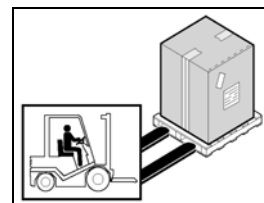

Zone d'installation

La zone préétablie devra être dûment éclairée et devra avoir une prise de courant électrique. Le plan d'appui doit être suffisamment ample, bien nivelé et sec. L'installation ne doit pas être exécutée dans des lieux avec une atmosphère explosive. En tous cas, l'installation doit être exécutée en tenant compte aussi des lois en vigueur en matière de sécurité dans le lieu de travail.

Branchement électrique

⚠ DANGER – ATTENTION: Le branchement électrique sur le réseau d'alimentation doit être exécuté par du personnel spécialisé.

S'assurer que l'installation de mise à la terre de l'usine fonctionne parfaitement. Vérifier que la tension de ligne (V) et la fréquence (Hz) correspondent à celles de la machine (Voir la plaquette d'identification et le schéma de câblage). La machine est dotée d'un câble électrique avec fiche. La fiche est branchée sur un interrupteur général mural doté d'un différentiel.

Branchement triphasé

Démarrer la machine pendant quelques secondes et vérifier si la rotation de l'accessoire est correcte. Si la rotation n'est pas correcte, déconnecter la tension et inverser deux des trois phases de la fiche.

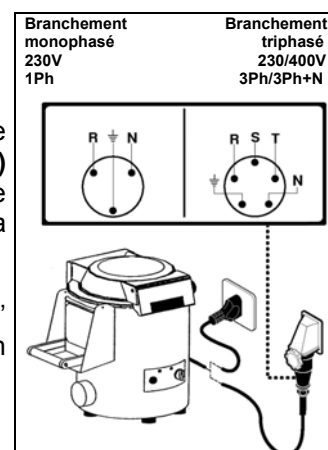

Branchement hydraulique

Effectuer la connexion au réseau hydrique au moyen du tuyau flexible (1500mm.) en dotation avec raccords de 3/4" selon les instructions suivantes:

-Raccorder le tuyau à l'entrée de l'eau **A** sur le côté postérieur de l'appareil.

-Rattacher l'autre extrémité du tuyau flexible au réseau hydrique. Un robinet **B** d'interception devra être installé avant l'appareil sur le tuyau d'alimentation.

-Le tuyau de décharge **C** devra être en pente pour favoriser l'évacuation des déchets; les conduites de décharge sous le plancher doivent avoir un $\varnothing 50\text{mm}$. pour les modèles PPN\LCN10-18-PPN25 et $\varnothing 90\text{mm}$. pour les modèles PPF\LCF5-10-18-PPF25. Le modèle PPN\LCN5, est un appareil de table qui doit décharger **D** dans un lavabo ou semblable placé à sa gauche.

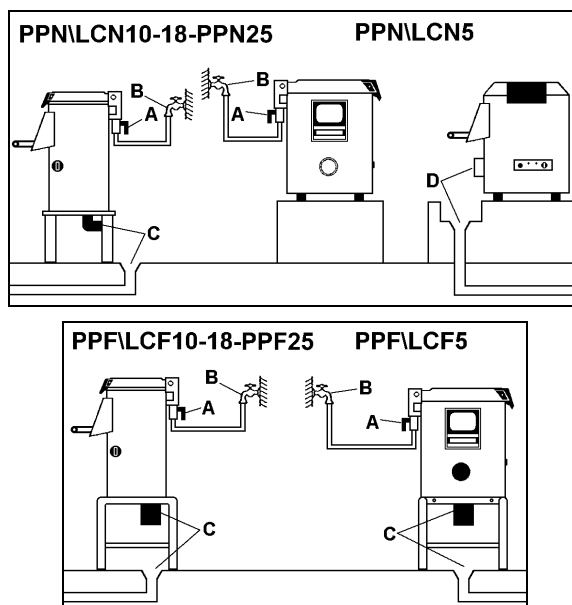

INFORMATION SUR L' EMPLOI ET LE NETTOYAGE **3**

Utilisation de la machine

Ouvrir le couvercle transparent en tirant le manche **A** jusqu'au déclenchement d'ouverture.

Insérer le disque et charger le récipient avec le produit à traiter.

Refermer le couvercle en le bloquant et s'assurer de l'enclenchement de la porte d'évacuation **B**.

Brancher l'interrupteur général au mur.

Mettre en marche l'appareil en tournant le bouton du temporisateur **C** sur le temp désiré pour le cycle de traitement.

Vérifier l'entrée de l'eau de lavage et agir manuellement sur le robinet **D** placé sur la machine.

A la fin du cycle programmé la machine s'arrêtera automatiquement.

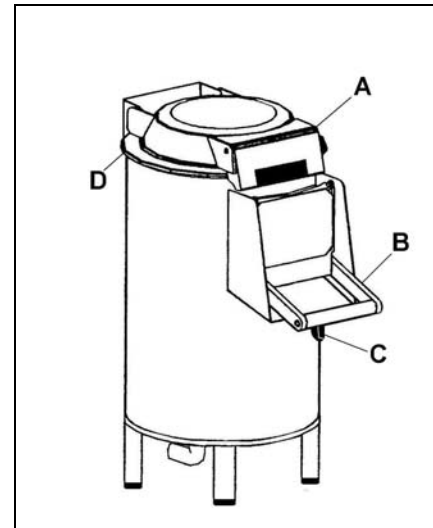
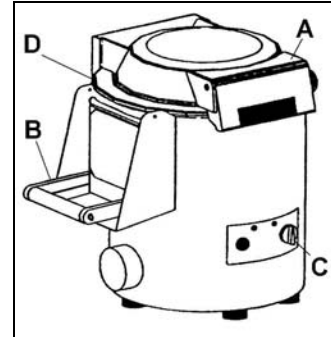

Il faut interrompre l'entrée de l'eau à l'intérieur de l'appareil en tournant le robinet **D**.

Pour enlever le produit traité ouvrir la porte d'évacuation **B** après avoir placé un bassin en-dessous de la bouche d'évacuation. Ensuite tourner le bouton du temporisateur **C** pour permettre la rotation à sec du disque et tenir avec l'autre main la porte d'évacuation de façon à contrôler l'évacuation du produit sans venir en contact.

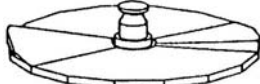
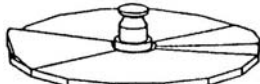

⚠ DANGER – ATTENTION: n'introduisez la main à travers la porte d'évacuation pour faciliter la sortie du produit.

Accessoires sur demande

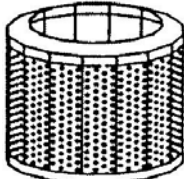
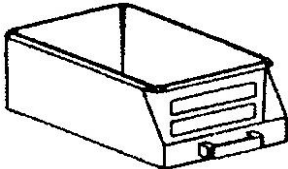
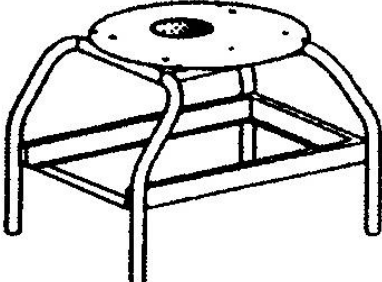
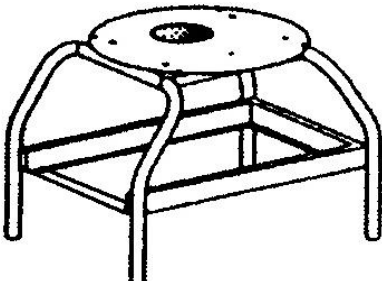
<p>PTA-PAB: éplucher les tubercules avec le disque abrasif (seulement mod.PPN\PPF5-10-18)</p>	
<p>PTB: éplucher les tubercules avec le disque abrasif (seulement mod.PPN\PPF25)</p>	
<p>PPC: nettoyer les moules et semblables avec le disque à brosse (seulement mod.LCN\LCF5-10-18)</p>	
<p>CCV: centrifuger les légumes à feuille moyennant le panier (seulement mod.PPN\PPF10-18-25)</p>	
<p>CCF: ramasser déchets (seulement mod.PPF\LCF5-10-18-PPF25)</p>	
<p>CI: modifier mod.PPN\LCN5-10-18 en mod.PPF\LCF5-10-18</p>	
<p>CB: modifier mod.PPN25 en mod.PPF25</p>	

PPN/PPF5X-10X-18X-25X LCN/LCF5X-10X-18X

D



KARTOFFELSCHÄLER UND MUSCHELWASCH-MASCHINE

INHALT

1 ALLGEMEINE HINWEISE

Beschreibung der Maschine.....	4
Technische Eigenschaften.....	4
Abmessungen.....	5

2 AUFSTELLUNG

Verpackung und Auspacken.....	7
Aufstellbereich.....	7
Elektrischer Anschluss.....	7
Wasseranschluß.....	7

3 GEBRAUCH UND REINIGUNG

Bedienung der Maschine.....	8
Zubehöre auf bestellung.....	9

ANLAGEN

Schaltplan

ALLGEMEINE HINWEISE 1

Beschreibung der Maschine

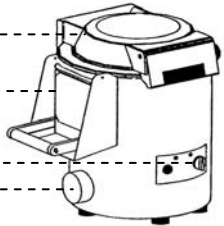
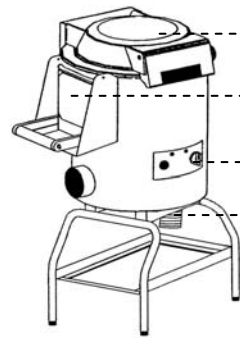
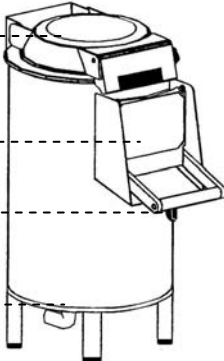
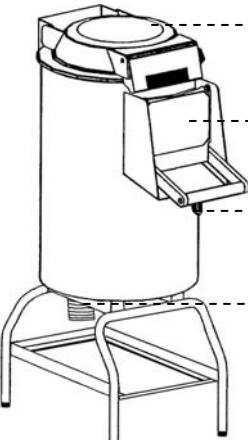
<p>MOD.PPN-LCN5</p>  <p>Deckel Auslaßtürchen Schalttafel Auslaßöffnung</p>	<p>MOD.PPF-LCF5</p>  <p>Deckel Auslaßtürchen Schalttafel Auslaßöffnung</p>
<p>MOD.PPN/LCN10-18-PPN25</p>  <p>Deckel Auslaßtürchen Schalttafel Auslaßöffnung</p>	<p>MOD.PPF/LCF10-18-PPF25</p>  <p>Deckel Auslaßtürchen Schalttafel Auslaßöffnung</p>

Technische Eigenschaften

Beschreibung	Maßeinheit	PPN5	PPF5	PPN10	PPF10	PPN18	PPF18	PPN25	PPF25
Stromversorgung	V Hz Ph	230V 50Hz 1Ph 230/400V 50Hz 3/3Ph+N							
Leistung	kW (HP)	0.37 (0.5)	0.37 (0.5)	0.75 (1)	0.75 (1)	1.1 (1.5)	1.1 (1.5)	1.1 (1.5)	1.1 (1.5)
Kartoffelbeladung	kg	5	5	10	10	18	18	25	25
Nettogewicht	kg	26	28	37	36	43	42	70	70
Gewicht mit Verpackung	kg	36	38	47	46	53	52	88	88
Aufstellen		Auf der Arbeitsfläche		Auf der Erde					

Beschreibung	Maßeinheit	LCN5	LCF5	LCN10	LCF10	LCN18	LCF18
Stromversorgung	V Hz Ph	230V 50Hz 1Ph 230/400V 50Hz 3/3Ph+N					
Leistung	kW (HP)	0.26 (0.35)	0.26 (0.35)	0.55 (0.75)	0.55 (0.75)	0.9 (1.2)	0.9 (1.2)
Kartoffelbeladung	kg	5	5	10	10	18	18
Nettogewicht	kg	26	28	37	36	43	42
Gewicht mit Verpackung	kg	36	38	47	46	53	52
Aufstellen		Auf der Arbeitsfläche		Auf der Erde			

Abmessungen

PPN-LCN5				PPN-LCN10				PPN-LCN18			
mm	A	B	C								
PPN-LCN5	500	750	920								
PPN-LCN10	550	850	1120								
PPN-LCN18	550	850	1120								
PPF-LCF5				PPF-LCF10				PPF-LCF18			
mm	A	B	C					A	B	C	mm
PPF-LCF5	500	750	920								
PPF-LCF10	550	850	1120								
PPF-LCF18	550	850	1120								
				+							
								ACCI			

Abmessungen

PPN25				PPF25			
mm	A	B	C	A	B	C	mm
PPN25	600	1050	1230	600	1050	1230	PPF25
				450	680	500	ACCB

AUFSTELLUNG 2

Verpackung und Auspacken

Damit die Unversehrtheit der Maschine während des Transports gewährleistet ist, wurde sie in einem mit Schaumpolystereinsatz verstärkten Karton verpackt.

- Die Verpackung gemäß den Anweisungen bewegen.
- Die Verpackung öffnen und alle Komponenten auf ihre Unversehrtheit überprüfen. Verpackung für spätere Umzüge aufbewahren.
- Die Maschine den Anweisungen gemäß heben und in den für die Aufstellung vorgesehenen Bereich positionieren.

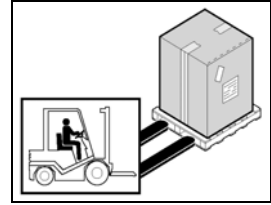

Aufstellbereich

Der dafür vorgesehene Bereich muss über eine geeignete Beleuchtung und über eine Steckdose zur Stromversorgung verfügen. Die Auflagefläche muss ausreichend breit, gut nivelliert und trocken sein. Die Aufstellung muss in einer nicht explosionsfähigen Umgebung erfolgen. Das Aufstellen muss in jedem Fall auch unter Berücksichtigung der auf dem Gebiet der Sicherheit am Arbeitsplatz geltenden Gesetze erfolgen.

Elektrischer Anschluss

⚠ GEFAHR - ACHTUNG: Der elektrische Anschluss an das Versorgungsnetz muss von Fachpersonal ausgeführt werden.

Volle Funktionstüchtigkeit der Erdungsvorrichtung der Anlage sicherstellen. Überprüfen, dass Leitungsspannung (**V**) und Frequenz (**Hz**) mit denen der Maschine übereinstimmen (Siehe Kennschild und Leitungsplan). Die Maschine ist mit einem elektrischen Kabel mit Stecker ausgerüstet. Der Stecker ist an einen mit einem Differential ausgerüsteten Wand-Netzschalter anzuschließen.

Dreiphasenanschluss

Maschine für wenige Augenblicke in Gang setzen und überprüfen, dass die Werkzeugumdrehung korrekt ist. Falls die Umdrehung nicht korrekt sein sollte, die Spannung ausschalten und zwei der drei Phasen im Stecker umkehren.

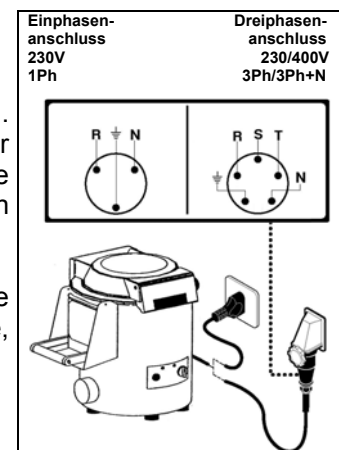

Wasseranschluß

Den Wassernetzanschluß mittels des in der Ausstattung vorhandenen Schlauches mit 3/4" Anschlüssen vornehmen. Folgendermaßen vorgehen:

-Am Wasserinfluß **A** an der Rückseite des Gerätes anschließen.

-Das andere Schlauchende mit dem Wassernetz verbinden. Ein Zuflußwasserhahn **B** muß stromaufwärts vom Gerät, auf der Speisewasserleitung installiert werden.

-Der Abfluß **C** muß geneigt sein, um so die Schlackenentleerung zu erleichtern; die Bodenleitung muß einen Durchmesser von $\varnothing 50\text{mm}$. (für mod.PPN\LCN10-18-PPN25) und von $\varnothing 90\text{mm}$. (für mod.PPF\LCF5-10-18-PPF25) haben. Das Modell PPN\LCN5 ein Tischgerät ist und deshalb muss in einem Waschbecken **D** oder in etwas Ähnlich auslassen, das an der linken Seite gestellt sein soll.

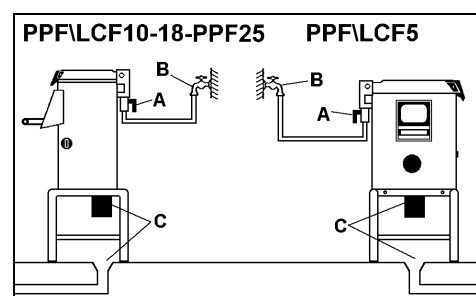
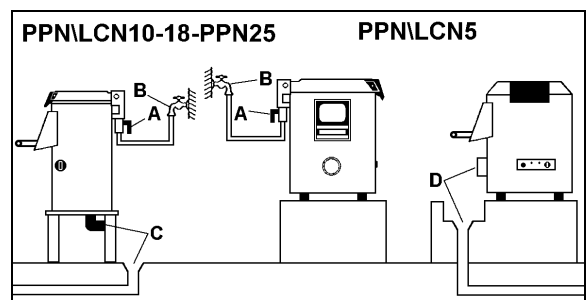

GEBRAUCH UND REINIGUNG 3

Bedienung der Maschine

Den durchsichtigen Deckel öffnen und den Handgriff **A** ziehen bis zum Erhöfnungsnellen..

Die Schälplatte stellen und die Wanne mit dem Produkt zu verarbeiten aufladen.

Den Deckel schliessen und blockieren; kontrollieren sie dass die Auslasstür **B** auch blockiert ist.

Den Hauptschalter auf der wand Einschalten.

Die Maschine einschalten durch drehung des Timerhandgriff **C** uaf der gewünschten arbeitzeit.

Um die Waschwassereintritt zu prüfen soll man manuell handeln auf dem hahn **D** der sich auf der Maschine befindet.

Am ende des Arbeitzyklus die Maschine automatisch stehenbleibt.

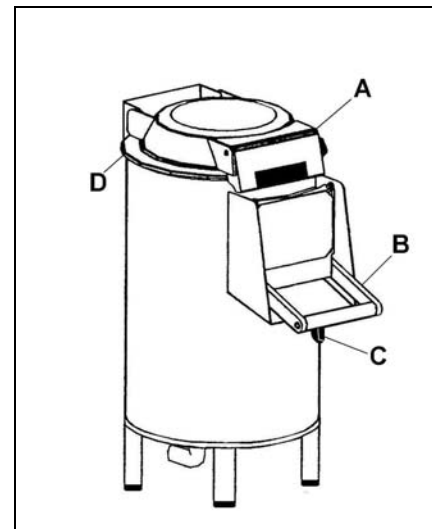
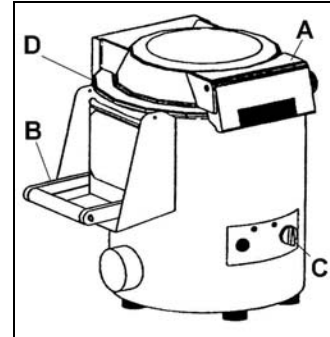

Unterbrechen sie die Wassereintritt durch hahn **D**.

Um das verarbeitetes Produkt zu ausladenein behälter unten die Auslasstür stellen und Auslasstür **B** öffnen, des Timerhandgriff **C** drehen so dass der Schälplatte dreht sich. Mit der anderen Hand die Auslasstür halten und die ausgang den Produkt kontrollieren um kein kontakt zu haben.

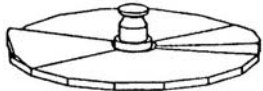

⚠ GEFAHR - ACHTUNG: Nie die Hand zur Entnahme des Produkts in die Öffnung geben.

Zubehöre auf Bestellung

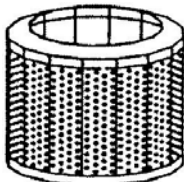
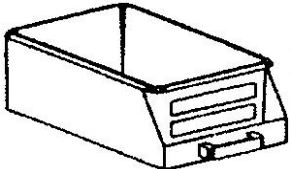
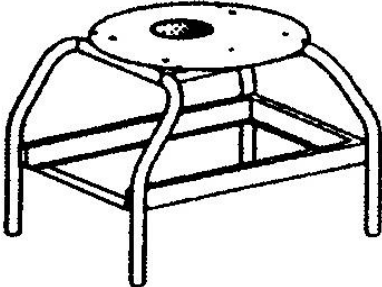
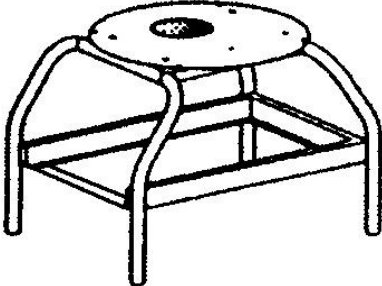
<p>PTA-PAB: Knollengemüse schälen mit der Schleifscheibe (nur mod.PPN\PPF5-10-18)</p>	
<p>PTB: Knollengemüse schälen mit der Schleifscheibe (nur mod.PPN\PPF25)</p>	
<p>PPC: Muscheln und gleichartiges putzen mit der Bürstenscheibe (nur mod.LCN\LCF5-10-18)</p>	
<p>CCV: Blattgemüse zentrifugieren mit der Trommel (nur mod.PPN\PPF10-18-25)</p>	
<p>CCF: Abfälle sammeln (nur mod.PPF\LCF5-10-18-PPF25)</p>	
<p>CI: Mod.PPN\LCN5-10-18 in Mod.PPF\LCF5-10-18 Ändern</p>	
<p>CB: Mod.PPN25 in Mod.PPF25 Ändern</p>	

PPN/PPF5X-10X-18X-25X

LCN/LCF5X-10X-18X

E



PELA-PATATAS Y LAVA-MEJILLONES

ÍNDICE

1 INFORMACIONES GENERALES

Descripción de la máquina.....	4
Características técnicas.....	4
Dimensiones totales.....	5

2 INFORMACIONES SOBRE LA INSTALACIÓN

Embalaje y desembalaje	7
Zona de instalación.....	7
Conexión eléctrica	7
Conexión hidráulica.....	7

3 INFORMACIONES SOBRE EL USO Y LA LIMPIEZA

Uso de la máquina.....	8
Accesorios a petición.....	9

ANEXOS

Esquema eléctrico

INFORMACIONES GENERALES 1

Descripción de la máquina

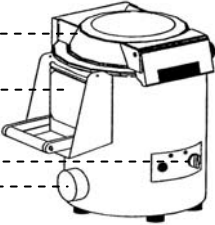
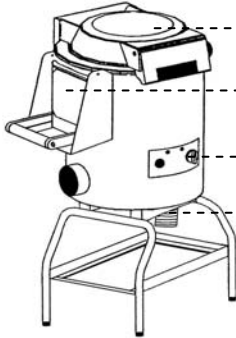
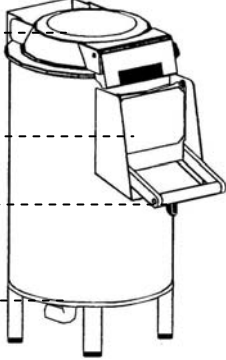
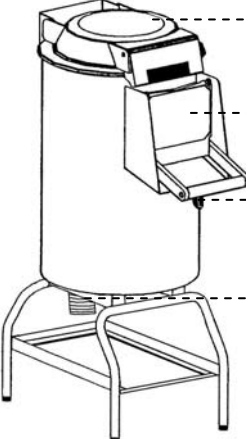
<p>MOD.PPN-LCN5</p>  <p>Tapa-----</p> <p>Portillo de evacuación-----</p> <p>Panel de control-----</p> <p>Evacuación agua-----</p>	<p>MOD.PPF-LCF5</p>  <p>-----Tapa</p> <p>-----Portillo de evacuación</p> <p>-----Panel de control</p> <p>-----Evacuación agua</p>
<p>MOD.PPN/LCN10-18-PPN25</p>  <p>Tapa-----</p> <p>Portillo de evacuación-----</p> <p>Panel de control-----</p> <p>Evacuación agua-----</p>	<p>MOD.PPF/LCF10-18-PPF25</p>  <p>-----Tapa</p> <p>-----Portillo de evacuación</p> <p>-----Panel de control</p> <p>-----Evacuación agua</p>

Características técnicas

Descripciones	Unidad de medida	PPN5	PPF5	PPN10	PPF10	PPN18	PPF18	PPN25	PPF25
Alimentación de energía eléctrica	V Hz Ph	230V 50Hz 1Ph 230/400V 50Hz 3/3Ph+N							
Potencia	kW (HP)	0.37 (0.5)	0.37 (0.5)	0.75 (1)	0.75 (1)	1.1 (1.5)	1.1 (1.5)	1.1 (1.5)	1.1 (1.5)
Carga patatas	kg	5	5	10	10	18	18	25	25
Peso neto	kg	26	28	37	36	43	42	70	70
Peso con embalaje	kg	36	38	47	46	53	52	88	88
Instalación		En el banco	En el piso						

Descripciones	Unidad de medida	LCN5	LCF5	LCN10	LCF10	LCN18	LCF18
Alimentación de energía eléctrica	V Hz Ph	230V 50Hz 1Ph 230/400V 50Hz 3/3Ph+N					
Potencia	kW (HP)	0.26 (0.35)	0.26 (0.35)	0.55 (0.75)	0.55 (0.75)	0.9 (1.2)	0.9 (1.2)
Carga patatas	kg	5	5	10	10	18	18
Peso neto	kg	26	28	37	36	43	42
Peso con embalaje	kg	36	38	47	46	53	52
Instalación		En el banco	En el piso				

Dimensiones totales

PPN-LCN5				PPN-LCN10				PPN-LCN18			
mm	A	B	C								
PPN-LCN5	500	750	920								
PPN-LCN10	550	850	1120								
PPN-LCN18	550	850	1120								

PPF-LCF5				PPF-LCF10				PPF-LCF18			
mm	A	B	C					A	B	C	mm
PPF-LCF5	500	750	920								
PPF-LCF10	550	850	1120	+				390	580	470	ACCI
PPF-LCF18	550	850	1120								

INFORMACIONES SOBRE LA INSTALACIÓN 2

Embalaje y desembalaje

La máquina está embalada en cartón con la introducción de espuma de poliestireno para garantizar su perfecta integridad durante el traslado.

- Mover el embalaje según las instrucciones.
- Abrir el embalaje y verificar la integridad de todos los componentes. Guardar el embalaje para eventuales y futuros traslados.
- Levantar la máquina tal como se indica y posicionarla en la zona destinada a la instalación.

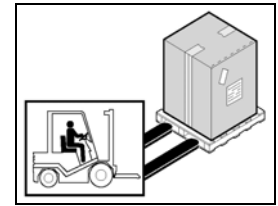

Zona de instalación

La zona pre-establecida deberá ser adecuadamente iluminada y disponer de una toma de distribución de la energía eléctrica. El plano de apoyo deberá ser suficientemente amplio, bien nivelado y seco. La instalación deberá efectuarse en lugares con atmósfera no explosiva. De todas formas, la instalación deberá realizarse también en el respeto de las leyes vigentes en materia de seguridad en el trabajo.

Conexión eléctrica

⚠ PELIGRO - ATENCIÓN: La conexión eléctrica a la red de alimentación debe ser realizada por personal especializado.

Verificar el buen estado de la instalación puesta a tierra del establecimiento. Verificar que la tensión de línea (**V**) y la frecuencia (**Hz**) correspondan a las de la máquina (Ver la placa de identificación y el esquema eléctrico). La máquina está dotada de un cable eléctrico con enchufe. El enchufe debe conectarse a un interruptor general de pared provisto de diferencial.

Conexión trifásica

Hacer funcionar la máquina durante unos segundos y verificar que la rotación del accesorio sea correcta. En caso contrario, quitar la tensión e invertir dos de las tres fases en el enchufe.

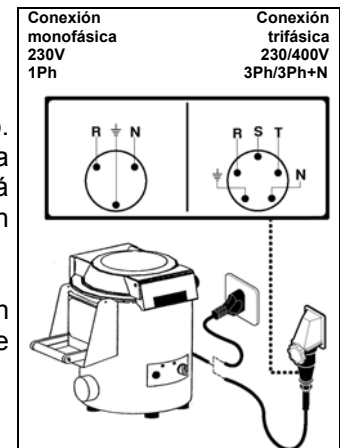

Conexión hidráulica

Efectuar la instalación a la red hídrica a través del tubo elástico (1500mm.) en dotación con enlaces de 3/4" procediendo de la siguiente manera:

-Conectarse a la entrada del agua **A** en la parte posterior del aparato.

-Conectar la otra extremidad del tubo elástico a la red hídrica. Un grifo **B** d'intercepción tendrá que ser instalado a monte del aparato, en la tubería de alimentación del agua.

-El tubo de evacuación del agua **C** tendrá que ser inclinada para favorecer la evacuación de las escorias; la tubería de descarga bajo el piso tiene que tener un $\varnothing 50\text{mm}$. para los modelos PPN\LCN10-18-PPN25 y $\varnothing 90\text{mm}$. para los modelos PPF\LCF5-10-18-PPF25. El modelo PPN\LCN5, es un aparato para el banco, tendrá descargar **D** en un lavabo o similar posicionado a izquierda.

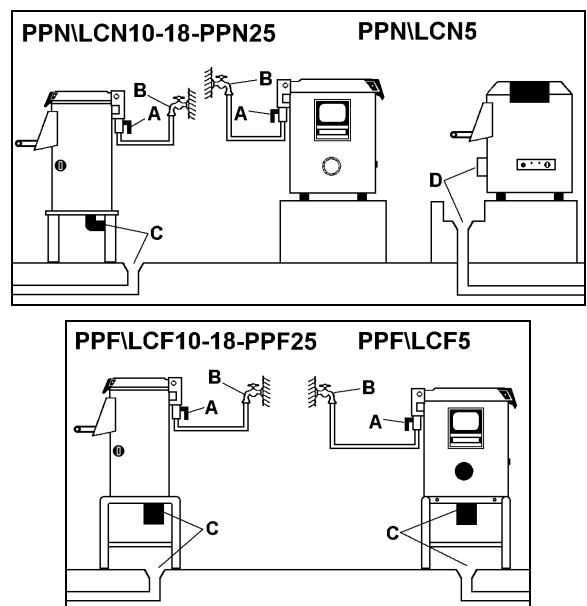

INFORMACIONES SOBRE EL USO Y LA LIMPIEZA **3**

Uso de la máquina

Abrir la tapa transparente tirando la manilla **A** hasta que el resorte de apertura no se abra.

Inserir el platillo y cargar el contenedor con el producto por tratar.

Cerrar la tapa bloqueandola y asegurarse de el bloqueo del portillo de evacuación **B**.

Inserir el interruptor general de pared.

Para poner en marcha el aparato gire la manopla del temporizador **C** sobre el tiempo deseado para el ciclo de trabajo.

Controlar la entrada del agua durante el lavado y intervenir manualmente en el grifo **D** colocado sobre la máquina.

Al final del ciclo impuesto la máquina se parará automáticamente.

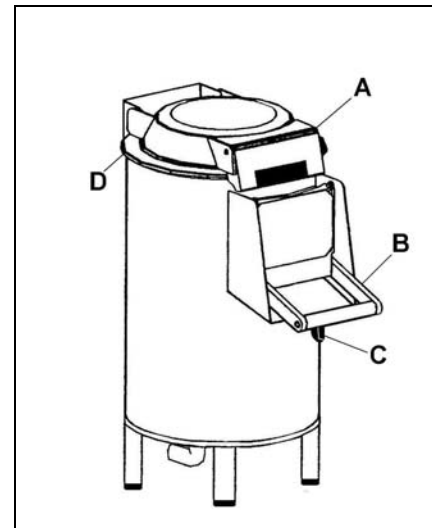
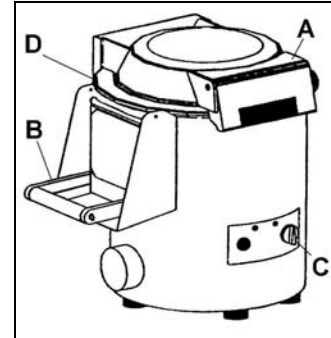

Interrumpir la entrada del agua girando el grifo **D**.

Para descargar el producto tratado abrir el portillo de evacuación **B** después de haber posicionado un contenedor bajo la boca de evacuación, luego girar la manopla del temporizador **C** para permitir la rotación a seco de el platillo y sujetar con la otra mano el portillo de evacuación de manera tal que se pueda controlar con éste.

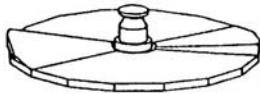

⚠ PELIGRO - ATENCIÓN: Non introducir nunca la mano a través del portillo de evacuación para favorecer la sobre salida del producto.

Accesorios a petición

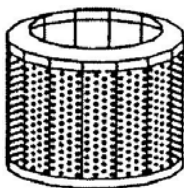
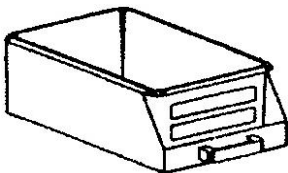
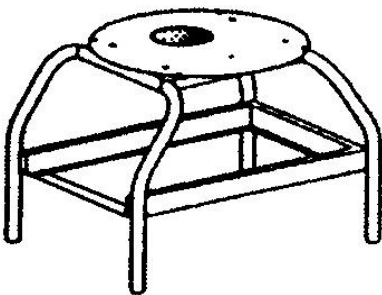
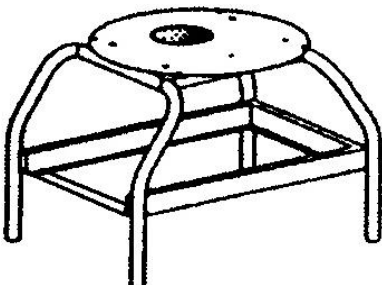
<p>PTA-PAB: pelar tubérculos con el platillo abrasivo (sòlo mod.PPN\PPF5-10-18)</p>	
<p>PTB: pelar tubérculos con el platillo abrasivo (sòlo mod.PPN\PPF25)</p>	
<p>PPC: limpiar mejillones y derivados con el platillo con cepillos (sòlo mod.LCN\LCF5-10-18)</p>	
<p>CCV: centrifugar verduras con hojas con el cesto (sòlo mod.PPN\PPF10-18-25)</p>	
<p>CCF: Recorger escorias (sòlo mod.PPF\LCF5-10-18-PPF25)</p>	
<p>CI: modificar mod.PPN\LCN5-10-18 en mod.PPF\LCF5-10-18</p>	
<p>CB: modificar mod.PPN25 en mod.PPF25</p>	

PPN/PPF5X-10X-18X-25X

LCN/LCF5X-10X-18X

P



DESCASCADORA DE BATATAS E LAVA MEXILHÃO

ÍNDICE

1 INFORMAÇÕES GERAIS

Descrição da máquina.....	4
Características técnicas.....	4
Dimensões de estorvo	5

2 INFORMAÇÕES SOBRE A INSTALAÇÃO

Embalagem e desembalagem.....	7
Zona de instalação.....	7
Ligação eléctrica.....	7
Ligação hidráulica	7

3 INFORMAÇÕES SOBRE O USO E A LIMPEZA

Uso da máquina.....	8
Acessórios a pedido.....	9

ANEXOS

Esquema eléctrico	
-------------------	--

INFORMAÇÕES GERAIS 1

Descrição da máquina

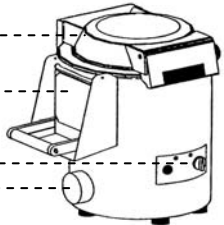
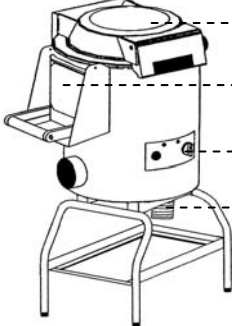
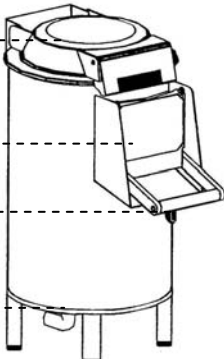
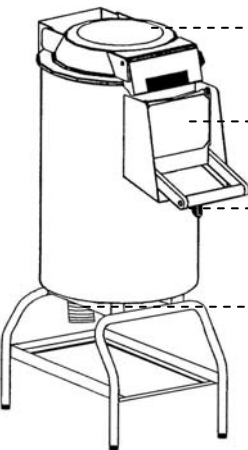
<p>MOD.PPN-LCN5</p>  <p>Tampa</p> <p>Postigo de descarga</p> <p>Painel dos comandos</p> <p>Descarga água</p>	<p>MOD.PPF-LCF5</p>  <p>Tampa</p> <p>Postigo de descarga</p> <p>Painel dos comandos</p> <p>Descarga água</p>
<p>MOD.PPN/LCN10-18-PPN25</p>  <p>Tampa</p> <p>Postigo de descarga</p> <p>Painel dos comandos</p> <p>Descarga água</p>	<p>MOD.PPF/LCF10-18-PPF25</p>  <p>Tampa</p> <p>Postigo de descarga</p> <p>Painel dos comandos</p> <p>Descarga água</p>

Características técnicas

Descrição	Unidade de medida	PPN5	PPF5	PPN10	PPF10	PPN18	PPF18	PPN25	PPF25
Alimentação de energia eléctrica	V Hz Ph	230V 50Hz 1Ph 230/400V 50Hz 3/3Ph+N							
Potência	kW (HP)	0.37 (0.5)	0.37 (0.5)	0.75 (1)	0.75 (1)	1.1 (1.5)	1.1 (1.5)	1.1 (1.5)	1.1 (1.5)
Carga mexilhões	kg	5	5	10	10	18	18	25	25
Peso líquido	kg	26	28	37	36	43	42	70	70
Peso com embalagem	kg	36	38	47	46	53	52	88	88
Instalação		No banco	Na terra						

Descrição	Unidade de medida	LCN5	LCF5	LCN10	LCF10	LCN18	LCF18
Alimentação de energia eléctrica	V Hz Ph	230V 50Hz 1Ph 230/400V 50Hz 3/3Ph+N					
Potência	kW (HP)	0.26 (0.35)	0.26 (0.35)	0.55 (0.75)	0.55 (0.75)	0.9 (1.2)	0.9 (1.2)
Carga mexilhões	kg	5	5	10	10	18	18
Peso líquido	kg	26	28	37	36	43	42
Peso com embalagem	kg	36	38	47	46	53	52
Instalação		No banco	Na terra				

Dimensões de estorvo

PPN-LCN5				PPN-LCN10				PPN-LCN18			
mm	A	B	C								
PPN-LCN5	500	750	920								
PPN-LCN10	550	850	1120								
PPN-LCN18	550	850	1120								

PPF-LCF5				PPF-LCF10				PPF-LCF18			
mm	A	B	C					A	B	C	mm
PPF-LCF5	500	750	920					390	580	470	ACCI
PPF-LCF10	550	850	1120								
PPF-LCF18	550	850	1120								

Dimensões de estorvo

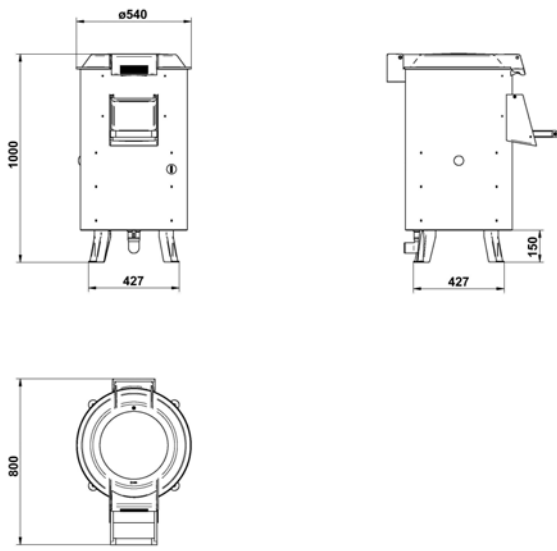
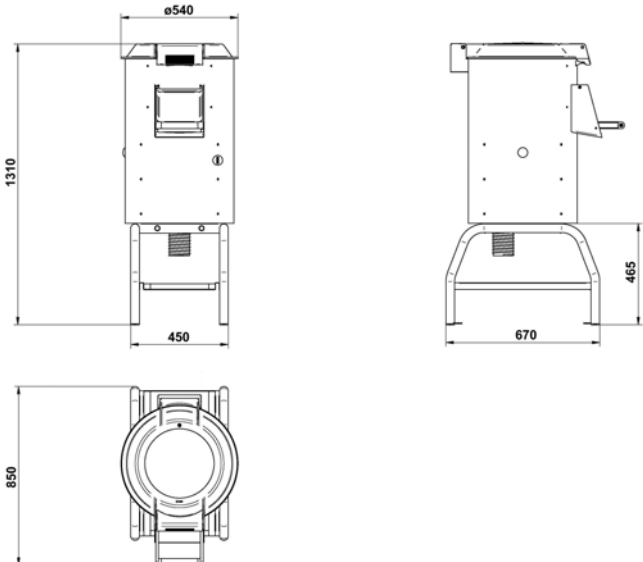
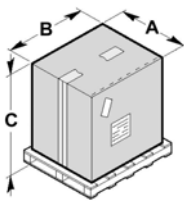
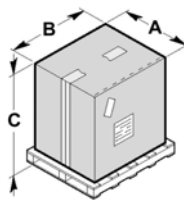
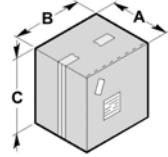
PPN25					PPF25				
									
MM	A	B	C			A	B	C	MM
PPN25	600	1050	1230			600	1050	1230	PPF25
						450	680	500	ACCB

INFORMAÇÕES SOBRE A INSTALAÇÃO 2

Embalagem e desembalagem

A máquina está embalada numa caixa de cartão com protecções de poliéster expando para garantir a perfeita integridade durante o transporte.

- Manuseie a embalagem respeitando as instruções.
- Abra a embalagem e verifique a integridade de todos os componentes. Conserve-a para um futuro transporte.
- Levante a máquina como indicado e coloque-a na zona escolhida para a instalação.

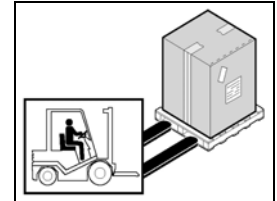

Zona de instalação

A zona escolhida deve estar bem iluminada e terá que dispor de tomadas eléctricas. O plano de apoio deve ser suficientemente amplo, bem nivelado e seco. A instalação deve ser efectuada em ambientes com atmosfera não explosiva, tendo em conta também as leis em vigor em matéria de segurança no trabalho.

Ligação eléctrica

⚠ PERIGO – ATENÇÃO: A ligação eléctrica à rede de alimentação deve ser efectuada por pessoal especializado.

Verifique a eficiência da instalação de ligação à terra do estabelecimento. Verifique que a tensão de linha (**V**) e a frequência (**Hz**) correspondam aos da máquina (veja a chapa de identificação e o esquema eléctrico). A máquina possui um cabo eléctrico que deve ser ligado a uma ficha multipolar que por sua vez deve ser ligada a um interruptor de parede dotado de diferencial.

Ligação trifásica

Ponha a máquina a funcionar durante alguns segundos e verifique a correcta rotação do utensílio. Em caso contrário, desligue a tensão e inverta duas das três fases na ficha.

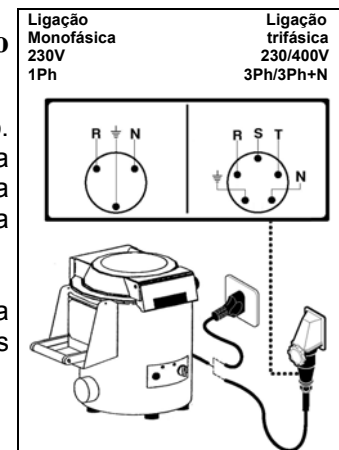

Ligação hidráulica

Predisponha a ligação à rede hídrica por meio do tubo flexível (1500mm.) no equipamento base com junções de 3/4" procedendo como indicado em seguida:

-Fixe uma extremidade do tubo flexível no ponto de entrada da água **A** na parte posterior do aparelho.

-Ligue a outra extremidade do tubo flexível à rede hídrica. Uma torneira **B** de interceptação deverá ser instalada antes da água no aparelho, na tubulação de alimentação da água.

-A descarga da água **C** deverá ser colocada numa posição inclinada para favorecer a evacuação das escórias; a tubulação de descarga sob o pavimento deve ter um $\varnothing 50\text{mm}$. para os modelos PPNLCN10-18-PPN25 e $\varnothing 90\text{mm}$. para os modelos PPF\LCF5-10-18-PPF25. O modelo PPNLCN5, como aparelho no banco, deverá descarregar **D** em um lavatory ou análogos colocado esquerdo da máquina.

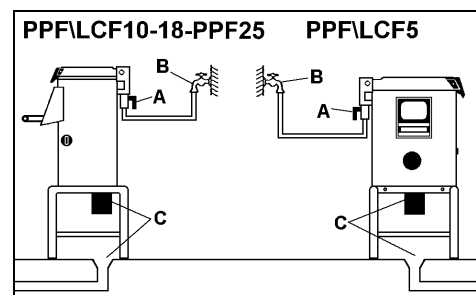
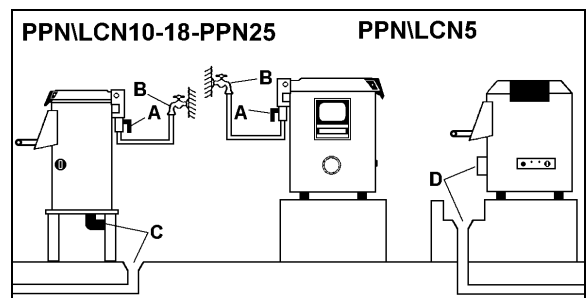

INFORMAÇÕES SOBRE O USO E A LIMPEZA 3

Uso da máquina

Abra a tampa transparente puxando a pega **A** até ao disparo de abertura.

Posicione o disco e carregue o tanque com o producto que deve ser preparado.

Volte a fechar a tampa bloqueando-a e assegure-se que o postigo de descarga **B** esteja bloqueado.

Ligue o interruptor geral de parade.

Coloque em funcionamento o aparelho rodando o botão do temporizador **C**.

Verifique a entrada da água de lavagem e deve intervir manualmente na torneira **D** instalada na parte posterior da máquina.

Uma vez concluído o ciclo pré-ajustado, a máquina interromperá automaticamente a sua marcha.

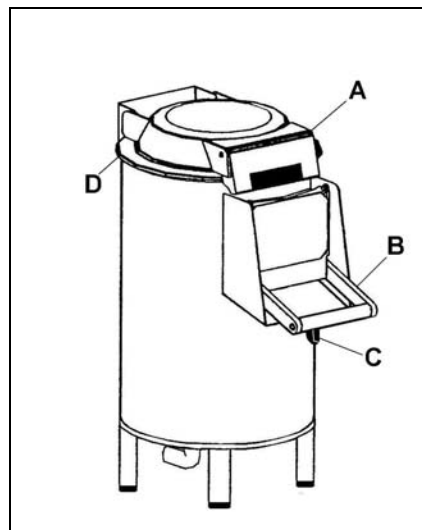
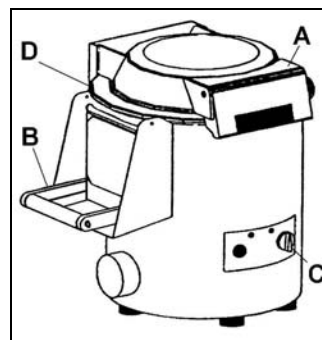

Interromper a imissão de água rodando a torneira **D**.

Para descarregar o producto preparado abra o postigo de descarga **B** depois de ter colocado um recipiente de colheita sob o mesmo postigo, em seguida rodar o botão do temporizador **C** para permitir a rotação a seco do disco e, com a outra mão, segure o postigo de descarga de forma a controlar a saída do producto sem entrar em contacto com o mesmo.

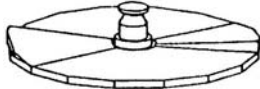
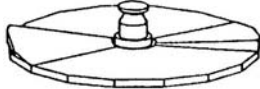

⚠ PERIGO – ATENÇÃO: Não enfie nunca a mão dentro do postigo de descarga para facilitar a saída do producto.

Acessórios a pedido

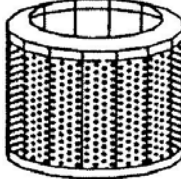
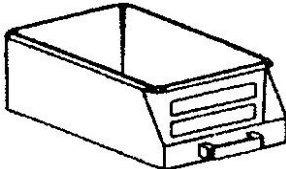
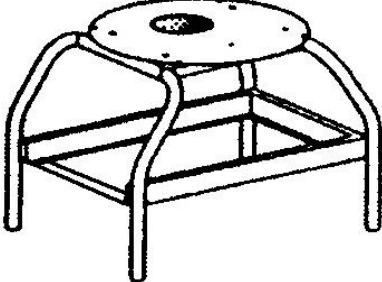
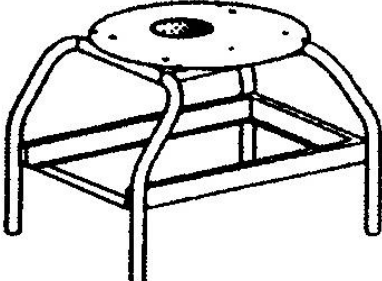
<p>PTA-PAB: descascar tubérculos com o disco abrasivo (só mod.PPN\PPF5-10-18)</p>	
<p>PTB: descascar tubérculos com o disco abrasivo (só mod.PPN\PPF25)</p>	
<p>PPC: limpar mexilhões e análogos com o disco de escovas (só mod.LCN\LCF5-10-18)</p>	
<p>CCV: centrifugar verduras de folha com o cesto (só mod.PPN\PPF10-18-25)</p>	
<p>CCF: recolhimento escórias (só mod.PPF\LCF5-10-18-PPF25)</p>	
<p>CI: modifique mod.PPN\LCN5-10-18 em mod.PPF\LCF5-10-18</p>	
<p>CB: modifique mod.PPN25 em mod.PPF25</p>	

PPN/PPF5X-10X-18X-25X LCN/LCF5X-10X-18X

РУ



КАРТОФЕЛЕЧИСТКА И ОЧИСТИТЕЛЬ МИДИЙ

СОДЕРЖАНИЕ

1 ОБЩАЯ ИНФОРМАЦИЯ

Описание машины	4
Технические характеристики	4
Габаритные размеры	5

2 ИНФОРМАЦИЯ ПО УСТАНОВКЕ

Упаковка и распаковка	7
Зона установки	7
Подключение к электросети	7
Подключение к сети водоснабжения	7

3 ИНФОРМАЦИЯ ПО ПРИМЕНЕНИЮ И ЧИСТКЕ

Эксплуатация машины	8
Дополнительные принадлежности	9

ПРИЛОЖЕНИЯ

Электрическая схема	
---------------------	--

ОБЩАЯ ИНФОРМАЦИЯ 1

Описание машины

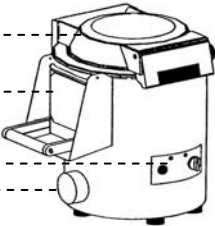
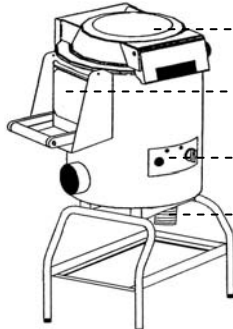
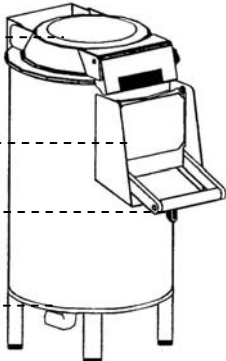
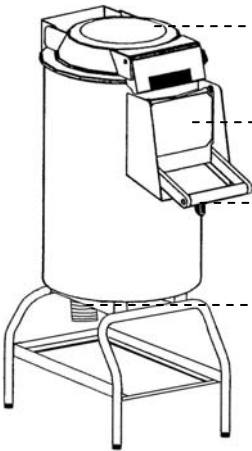
<p>МОД. PPN-LCN5</p> <p>Крышка</p> <p>Дверка выгрузки</p> <p>Панель управления</p> <p>Спуск воды</p> 	<p>МОД. PPF-LCF5</p> <p>Крышка</p> <p>Дверка выгрузки</p> <p>Панель управления</p> <p>Спуск воды</p> 
<p>МОД. PPN/LCN10-18-PPN25</p> <p>Крышка</p> <p>Дверка выгрузки</p> <p>Панель управления</p> <p>Спуск воды</p> 	<p>МОД. PPF/LCF10-18-PPF25</p> <p>Крышка</p> <p>Дверка выгрузки</p> <p>Панель управления</p> <p>Спуск воды</p> 

Технические характеристики

Описание	Единица измерения	PPN5	PPF5	PPN10	PPF10	PPN18	PPF18	PPN25	PPF25
Электрическое питание	В Гц Ф	230В 50Гц 1Ф 230/400В 50 Гц 3Ф							
Мощность	кВт (л.с.)	0.37 (0.5)	0.37 (0.5)	0.75 (1)	0.75 (1)	1.1 (1.5)	1.1 (1.5)	1.1 (1.5)	1.1 (1.5)
Загрузка картофеля	кг	5	5	10	10	18	18	25	25
Вес нетто	кг	26	28	37	36	43	42	70	70
Вес с упаковкой	кг	36	38	47	46	53	52	88	88
Установка		На столе	На полу						

Описание	Единица измерения	LCN5	LCF5	LCN10	LCF10	LCN18	LCF18
Электрическое питание	В Гц Ф	230В 50Гц 1Ф 230/400В 50 Гц 3Ф					
Мощность	кВт (л.с.)	0.26 (0.35)	0.26 (0.35)	0.55 (0.75)	0.55 (0.75)	0.9 (1.2)	0.9 (1.2)
Загрузка картофеля	кг	5	5	10	10	18	18
Вес нетто	кг	26	28	37	36	43	42
Вес с упаковкой	кг	36	38	47	46	53	52
Установка		На столе	На полу				

Габаритные размеры

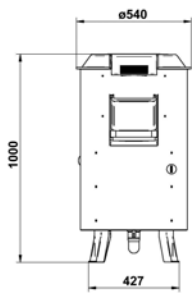
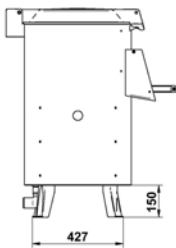
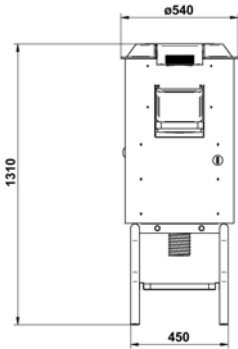
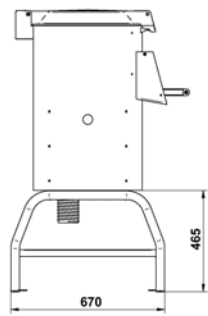
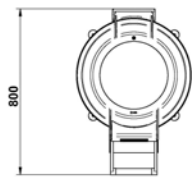
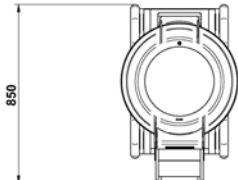
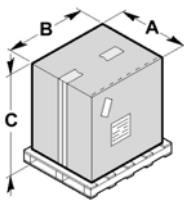
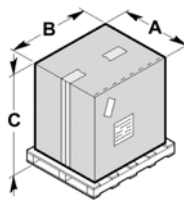
PPN25				PPF25			
							
							
MM	A	B	C	A	B	C	MM
PPN25	600	1050	1230	600	1050	1230	PPF25
				450	680	500	ACCB

ИНФОРМАЦИЯ 2 ПО УСТАНОВКЕ

Упаковка и распаковка

Машина упакована в картонную упаковку с наполнением из пенопласта для обеспечения целостности машины во время ее транспортировки

- Производить перемещение упакованного оборудования в соответствии с инструкциями.
- При открытии упаковки удостовериться в целостности каждого компонента. Сохранить упаковку на случай дальнейших перевозок..
- Произвести подъем машины в соответствии с предоставленными указаниями и поместить ее в зону, предназначенную для установки.

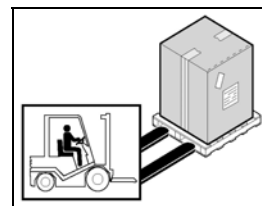

Зона установки

Выбранная зона должна быть достаточно освещенной и располагать электрическим разъемом. Опорная поверхность должна быть достаточно широкой, ровной и сухой. В установочной зоне должна присутствовать невзрывоопасная атмосфера. Установка должна проводиться в соответствии с действующим законодательством по безопасности на рабочих местах.

Таблица Условий внешней среды

Описание	Значения
Рабочая температура	0+35 °C (32+95 °F)
Температура хранения	от -15 до +65 °C (от -6.8 до +149 °F)
Относительная влажность	Макс 80% при температуре окружающей среды 20 °C Макс 50% при температуре окружающей среды 20+60 °C
Содержание пыли в помещении	Менее 0.03 г/м ³

Подключение к электросети

⚠ ОПАСНОСТЬ – ВНИМАНИЕ: подключение к сети

электропитания должно производиться специализированным персоналом.

Убедиться в полной исправности системы заземления в помещении. Убедиться в том, что напряжение линии (В) и частота (Гц) соответствуют характеристикам машины (См. идентификационную табличку и схему электрической цепи). Машина оснащена электрокабелем для подсоединения к многополюсному штепселю. Штепсель подсоединяется к настенному выключателю, оснащенному дифференциалом.

Трехфазное подсоединение

Включить машину на несколько секунд для проверки правильности вращения частей прибора. Если вращение неправильное, отключите напряжение и поменяйте местами две из трех фаз штепселя.

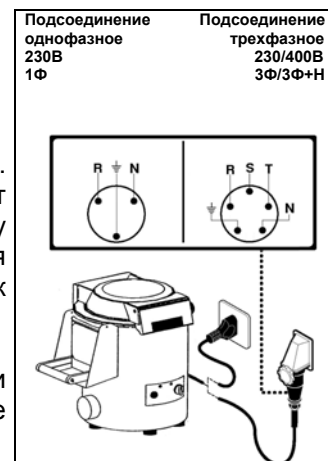

Подключение к сети водоснабжения

Выполнить подключение к сети водоснабжения с помощью гибкого шланга, входящего в комплектацию (1500мм.) с разъемами 3/4", действуя следующим образом:

-Подсоединиться ко входу воды **A** с задней стороны прибора.

-Подсоединить другой конец гибкого шланга к сети водоснабжения. Отсекающий кран **B** должен быть установлен выше прибора на трубопроводе водоснабжения.

-Слив **C** должен находиться под наклоном для способствования удалению отходов; сливной трубопровод должен иметь $\varnothing 50\text{мм}$ для моделей PPN\LCN10-18-PPN25 и $\varnothing 90\text{мм}$ для PPF\LCF5-10-18-PPF25. В настольной модели PPN\LCN5 слив производится **D** в ванну или раковину, помещенную слева от машины.

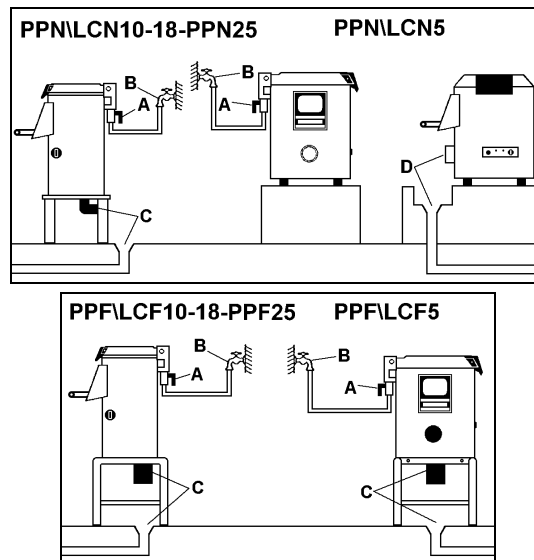

ИНФОРМАЦИЯ ПО ПРИМЕНЕНИЮ И ЧИСТКЕ **3**

Эксплуатация машины

Открыть прозрачную крышку, потянув рукоятку **A** до щелчка открытия.

Вставить нужный диск и загрузить обрабатываемый продукт в резервуар

Закрыть и заблокировать крышку и проверить блокировку дверки выгрузки **B**.

Включить главный выключатель на стене.

Включить машину, установив ручку **C** таймера требуемое время для рабочего цикла.

Проверить вход промывочной воды в следует повернуть кран **D** на машине.

По завершению заданного рабочего цикла машина автоматически остановится.

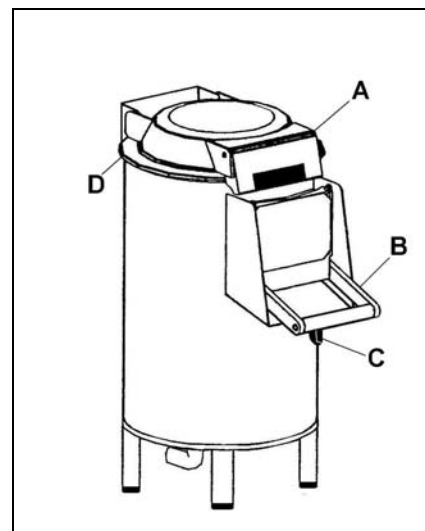
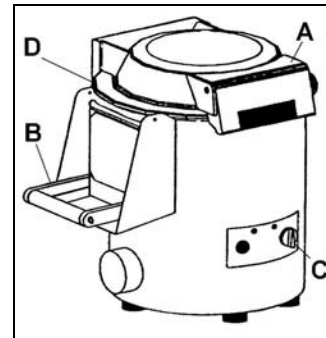

Отключить подачу воды с помощью крана **D**.

Для выгрузки обрабатываемого продукта следует открыть дверку выгрузки **B**, предварительно разместив под ней емкость для сбора, затем, установив ручку **C** таймера, чтобы позволить вращение диска вхолостую, держать при этом другой рукой дверку выгрузки, чтобы контролировать выход продукта, не соприкасаясь с ним.

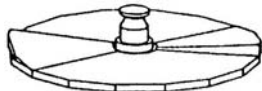

⚠ ОПАСНОСТЬ – ВНИМАНИЕ: Запрещается помещать руку в проем выгрузки в попытке облегчить выход продукта.

Дополнительные принадлежности

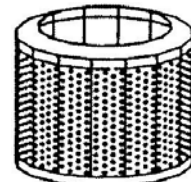
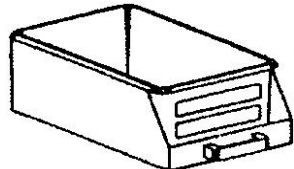
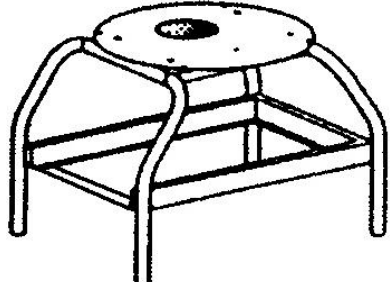
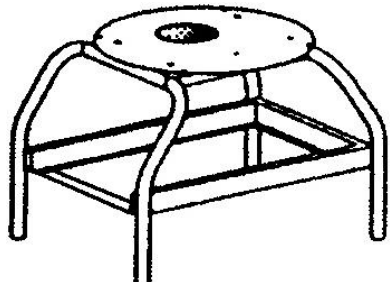
<p>РТА-РАВ: для очистки корнеплодов абразивным диском (только мод. PPN\PPF5-10-18)</p>	
<p>РТВ: для очистки корнеплодов абразивным диском (только мод. PPN\PPF25)</p>	
<p>РРС: для чистки мидий и моллюсков диском со щетками (только мод. LCN\LCF5-10-18)</p>	
<p>CCV: для мойки в центрифужном барабане листьев овощей (только мод. PPN\PPF10-18-25)</p>	
<p>CCF: для сбора отходов (только мод. PPF\LCF5-10-18-PPF25)</p>	
<p>СІ: для модификации мод. PPN\LCN5-10-18 в мод. PPF\LCF5-10-18</p>	
<p>СВ: для модификации мод. PPN25 в мод. PPF25</p>	

SCHEMA ELETTRICO • ELECTRICAL WIRING DIAGRAM •
SCHÉMA ÉLECTRIQUE • SCHALTPLAN • ESQUEMA ELECTRICO •
ESQUEMA ELÉCTRICO • ЭЛЕКТРИЧЕСКАЯ СХЕМА

(1 phase)

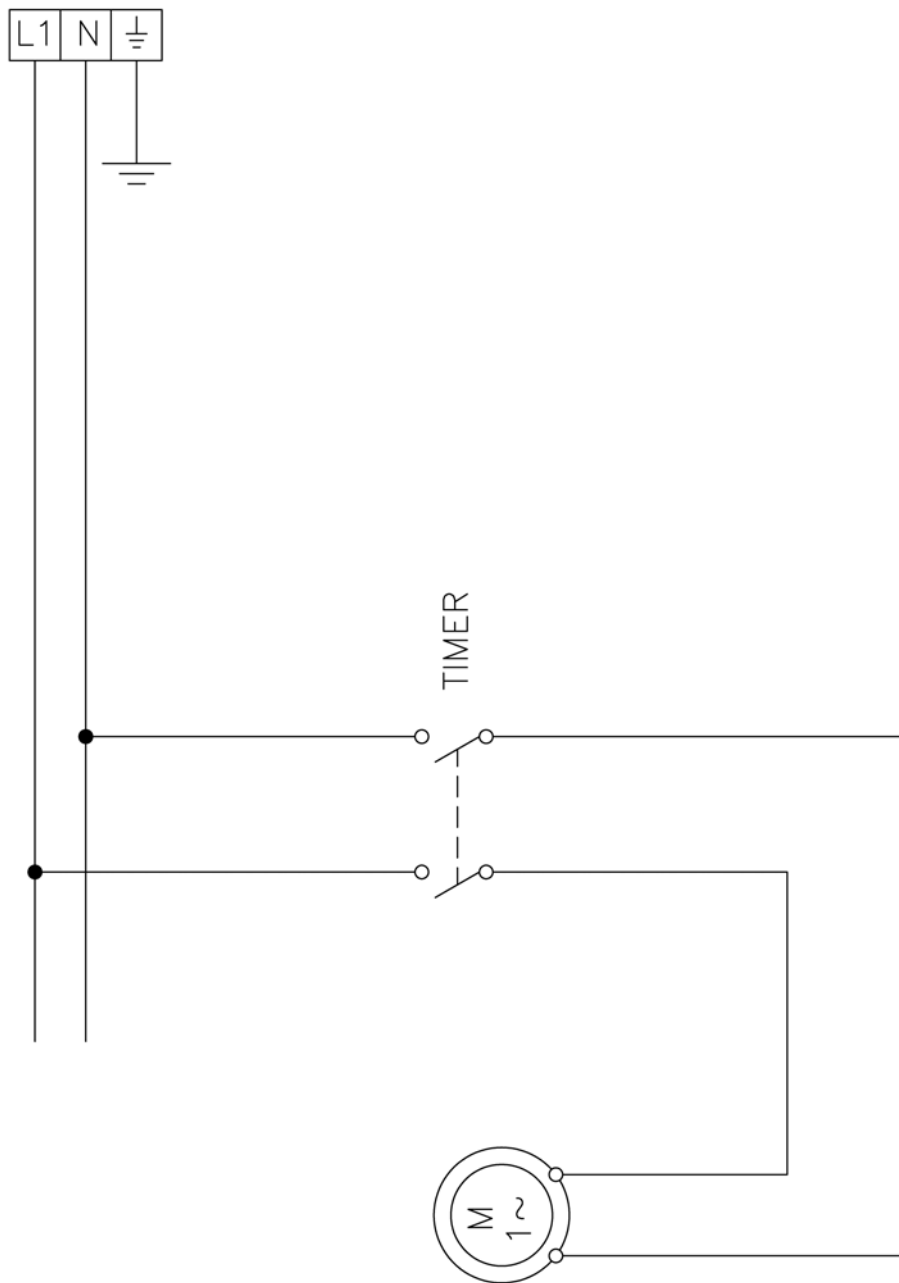

**SCHEMA ELETTRICO • ELECTRICAL WIRING DIAGRAM •
SCHÉMA ÉLECTRIQUE • SCHALTPLAN • ESQUEMA ELECTRICO •
ESQUEMA ELÉCTRICO • ЭЛЕКТРИЧЕСКАЯ СХЕМА**

(3 phase)

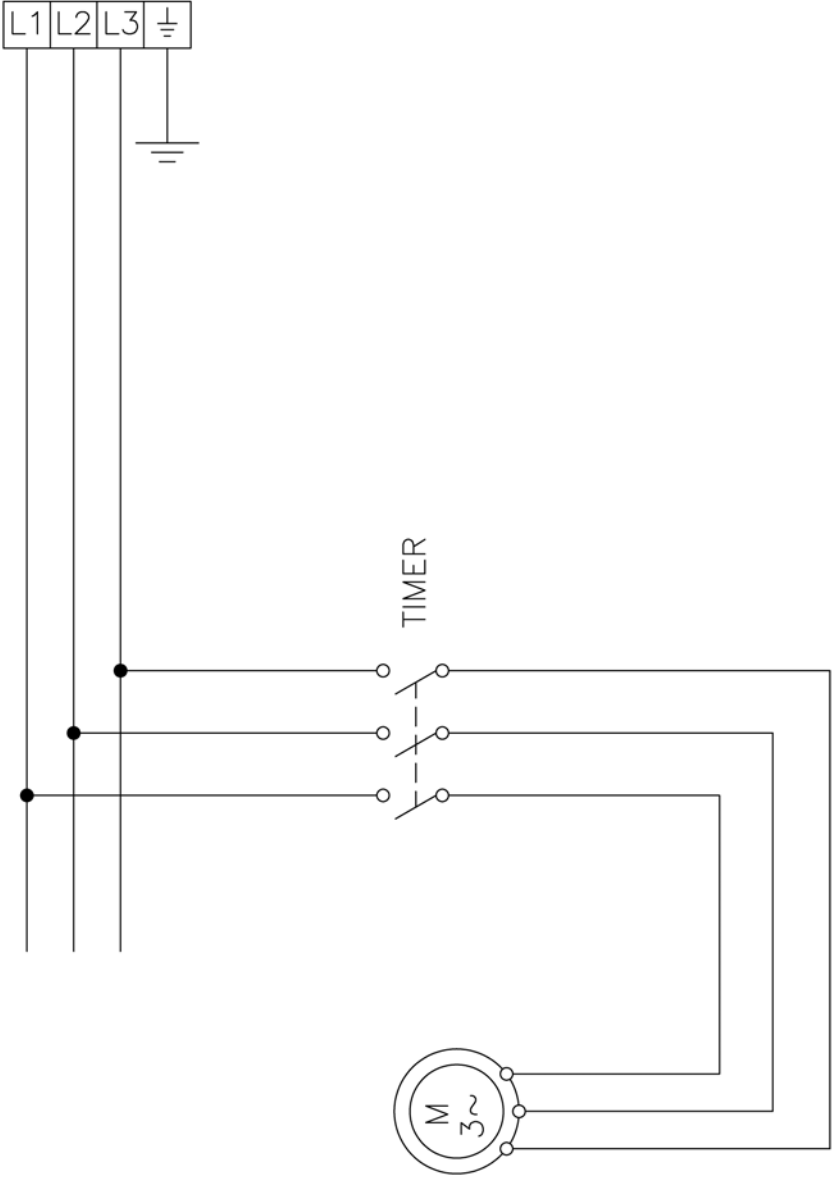



fimar

Via Sandro Pertini, 29
47826 Villa Verucchio – Rimini (Italy)
e-mail: mail@fimarspa.it
<http://www.fimarspa.it>

